

WWW.XENONDEPOT.COM

SPECIALIZING IN PROFESSIONAL HID CONVERSIONS

Hid Conversion Kit

■ Installation Step

BULB INSTALLATION:

- 1) IN ORDER TO AVOID ELECTRIC SHOCK, PLEASE REMOVE THE NEGATIVE TERMINAL FROM THE BATTERY
- 2) MAKE SURE THERE IS SUFFICIENT WORKING ROOM TO SAFELY INSTALL HID BULB IN HEADLIGHT ASSEMBLY. SOME VEHICLES WILL REQUIRE INSTALLER TO REMOVE HEADLIGHT ASSEMBLY DUE TO LACK OF SPACE.
- 3) DRILL A 23 MM. HOLE IN THE CENTER OF THE OEM HEADLIGHT RUBBER GROMMET / DUST COVER (MAY NOT APPLY).
- 4) SLIDE THE RUBBER GROMMET ON THE HID BULB WIRES INTO THE DRILLED HOLE TO CREATE A SECURE SEAL WITH OEM DUST COVER / GROMMET (MAY NOT APPLY).

CAUTION:

- 1) SOME VEHICLES WITH ONBOARD COMPUTERS MAY EXPERIENCE A LOW BEAM FAILURE INDICATION. THIS IS NORMAL AS HIDS RUN ON 35W AS OPPOSED TO OEM 55W.
- 2) PLEASE ALLOW SUFFICIENT TIME FOR HID COMPONENTS TO COOL DOWN BEFORE ATTEMPTING ANY REPLACEMENT PROCEDURES. NOT DOING SO MAY RESULT IN INJURY.
- 3) PLEASE INSTALL BALLASTS AND BULBS SECURELY AWAY FROM MOVING PARTS. AVOID ANY LOOSE WIRES OR SHARP EDGES WITHIN THE ENGINE BAY TO AVOID DAMAGE.
- 4) DO NOT DISASSEMBLE OR MODIFY THIS PRODUCT TO AVOID ELECTRIC SHOCK.
- 5) AVOID STARING DIRECTLY AT IGNITED BULB TO AVOID INJURY.
- 6) VEHICLES USING THE SAME BULB FOR DAYTIME RUNNING LIGHTS (DRL) AND LOW BEAMS MAY NEED TO DEACTIVATE OR ENSURE A CONSTANT 12V.
- 7) CONSUMER/INSTALLER AGREE TO TERMS SPECIFIED ON:





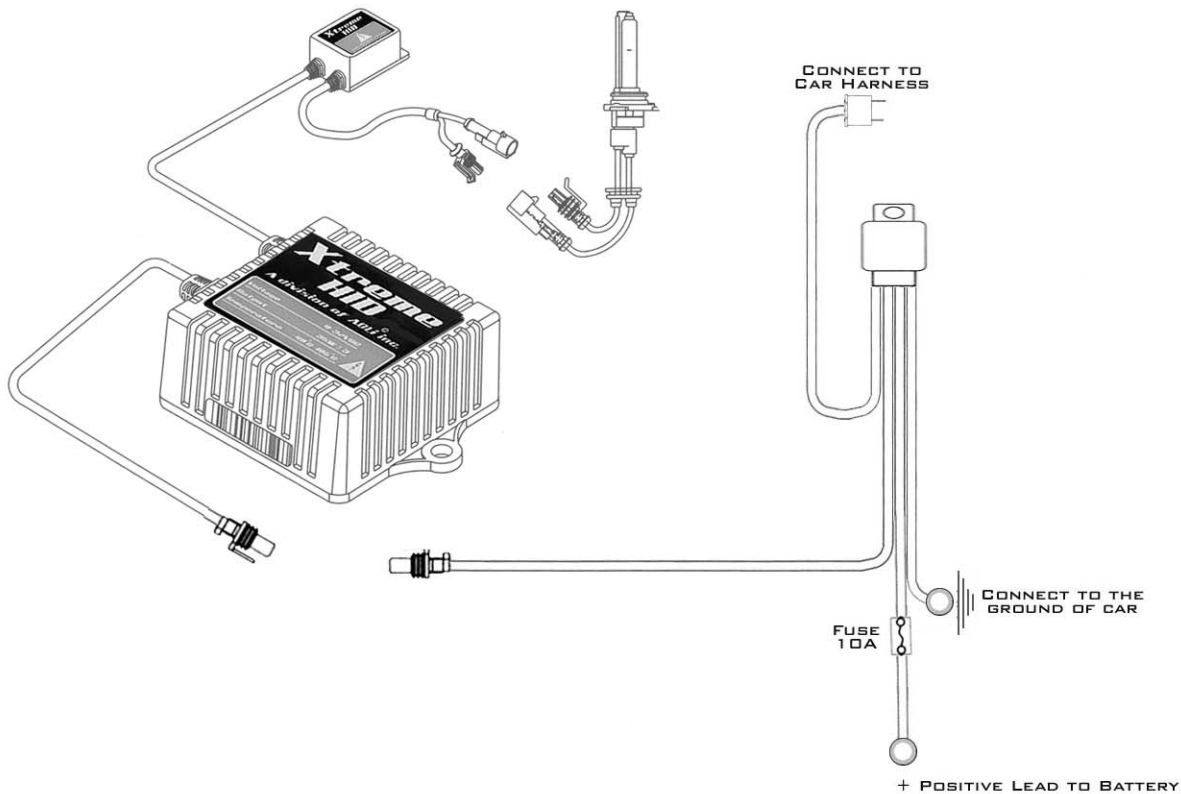

WWW.XENONDEPOT.COM

SPECIALIZING IN PROFESSIONAL HID CONVERSIONS

Hid Conversion Kit



Warning and Cautions:

-  *High Voltage system. Do not disassemble or modify to avoid injury.*
-  *Please allow sufficient time for HID components to cool down before handling.*
-  *Do not look directly into the bulb when ignited to avoid eye injuries.*
-  *When handling any part of the HID system, please ensure that your headlight switch is turned off.*
-  *Please do not frequently switch the bulbs on/off as doing this will cause the components to burn out prematurely.*
-  *For optimum performance, do not touch the bulb with bare hands. Clean bulb with alcohol if touched by accident.*